

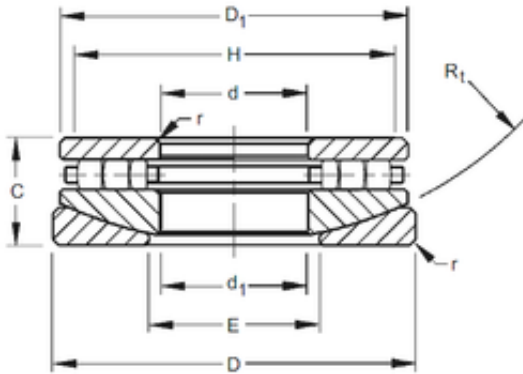

BEARING-MALAYSIA SDN.BHD.

160TPS166 Timken Thrust Cylindrical Roller Bearing



Bearing No. 160TPS166

Bore Diameter	406,4 mm
Outer Diameter	685,8 mm
d	406,4 mm
D	685,8 mm
r max	6,4 mm
d1	412,75 mm
C	152,4 mm
D1	657,22 mm
E	469,9 mm
H	633,4 mm
R	752,48 mm

160TPS166 Bearing 2D drawings and 3D CAD models